



三 壑 力 達

Leader Samco



Leader Samco A7S/A8S

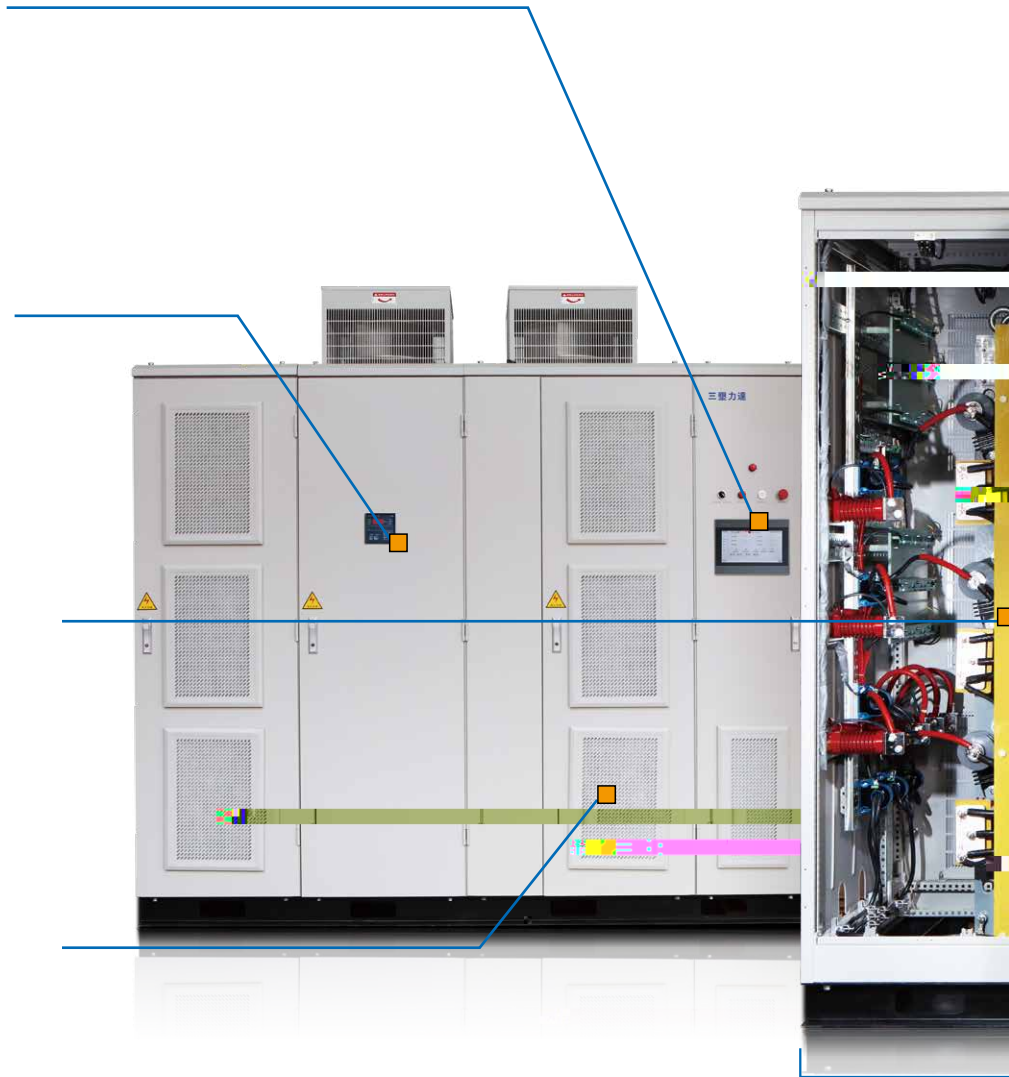

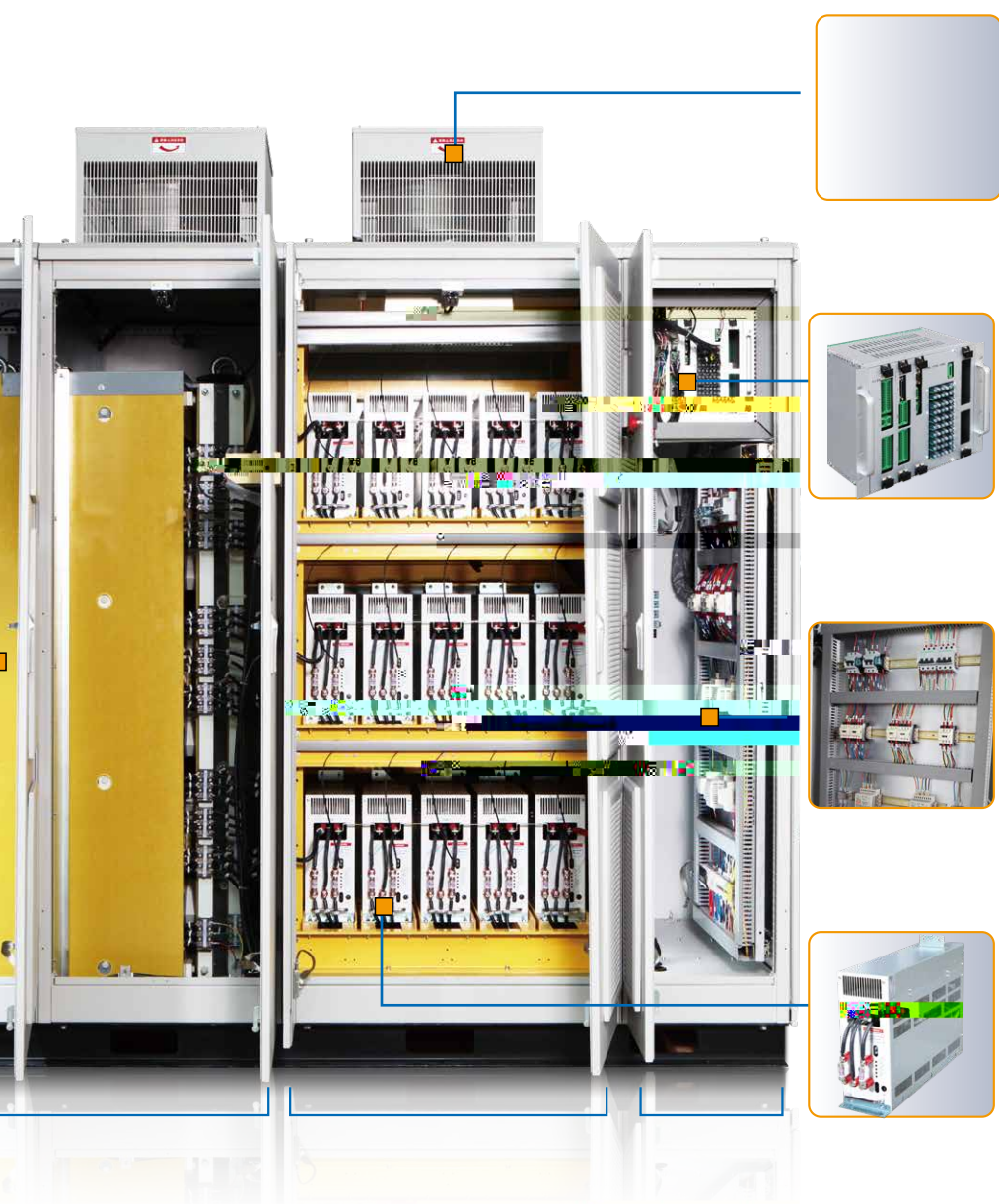

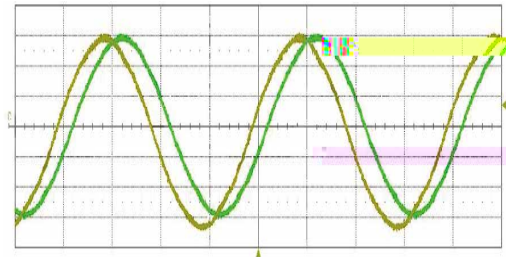
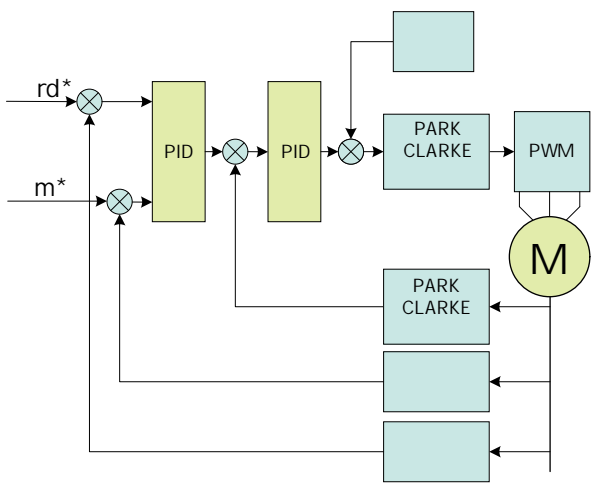

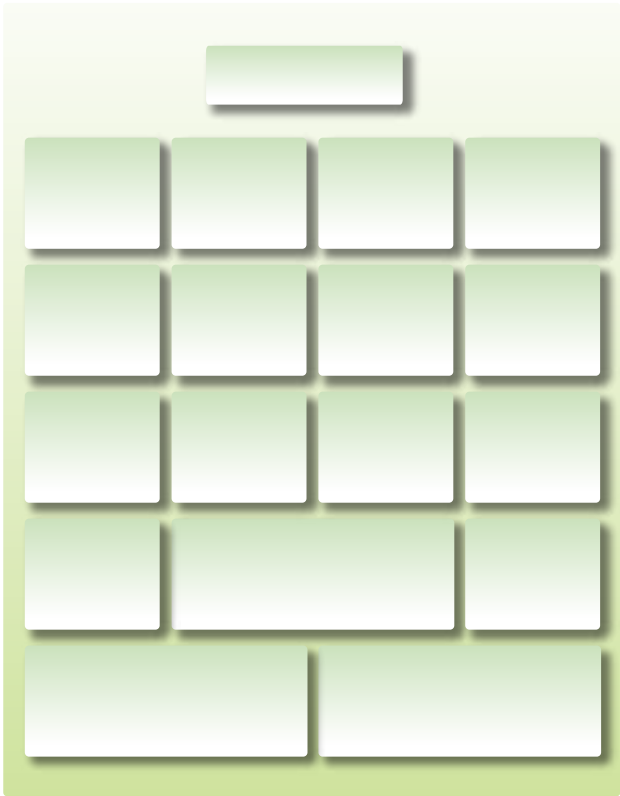
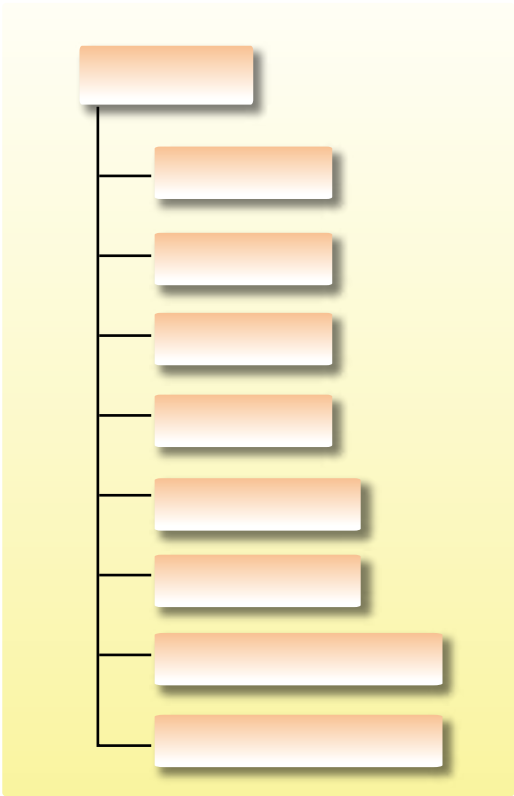

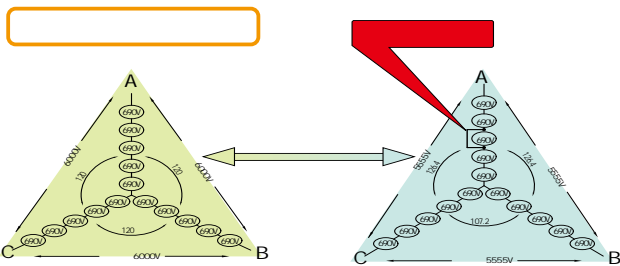
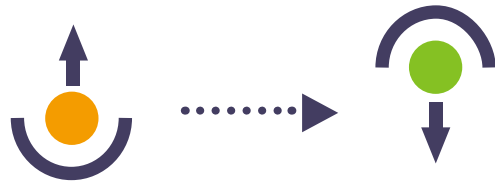
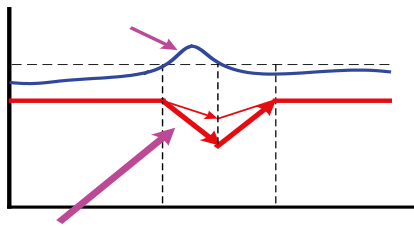
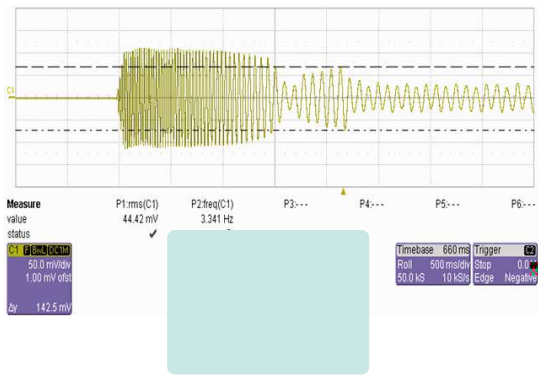
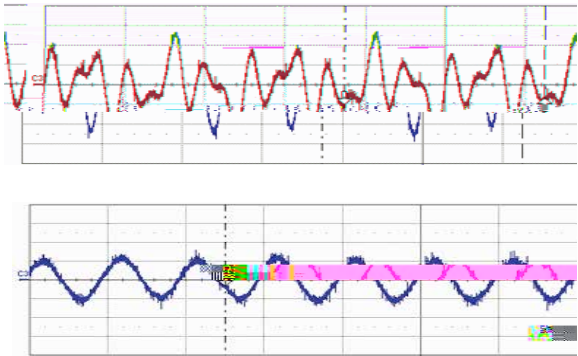



V/f

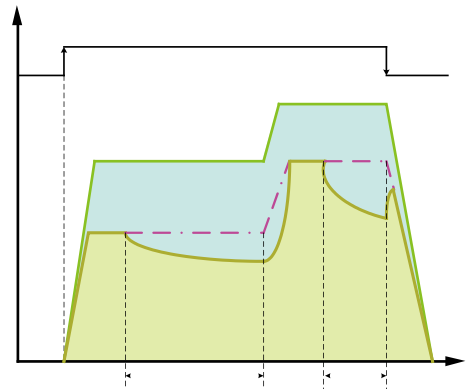
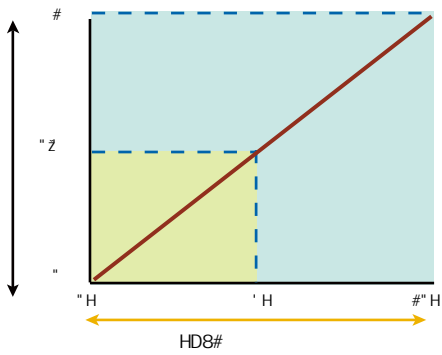

V/f

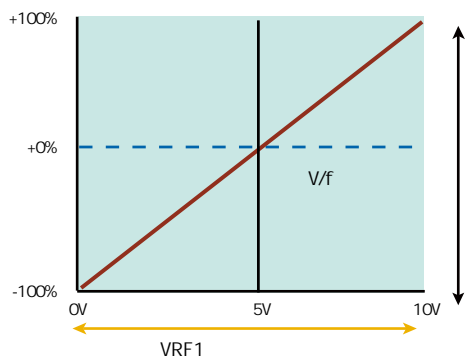

-
-
-
-
-
-
-

V/f





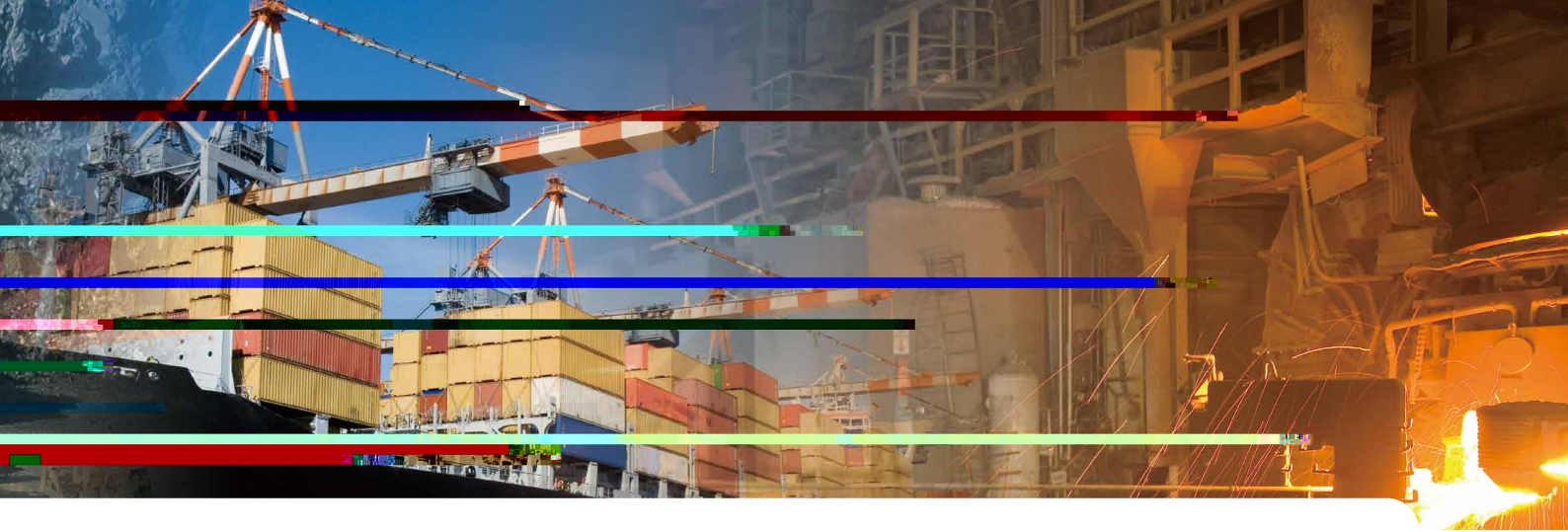

-
-
-
-
-
-
-
-

-
-
-
-

■ PID



Leader Samco A7S/A8S

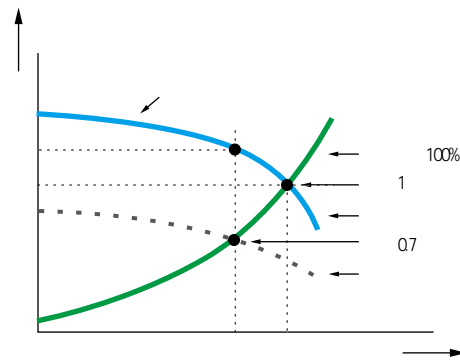
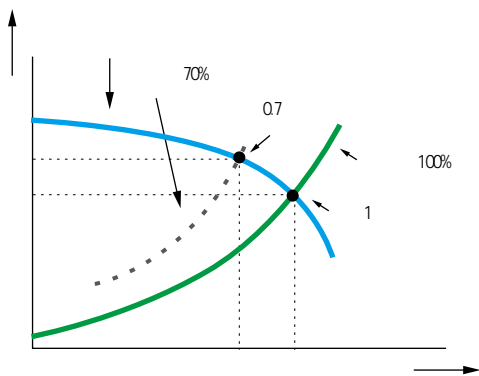

Leader Samco-A7S 3kV

o

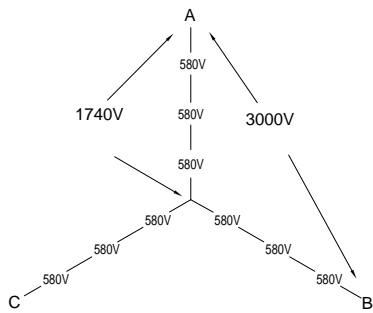

A7S 3kV

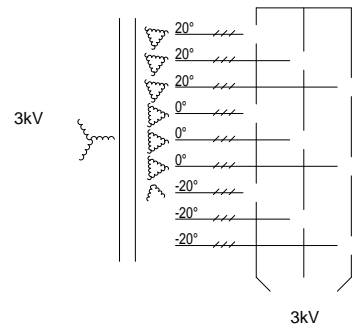

A7S 3kV

Leader Samco-A7S 3.3kV

o

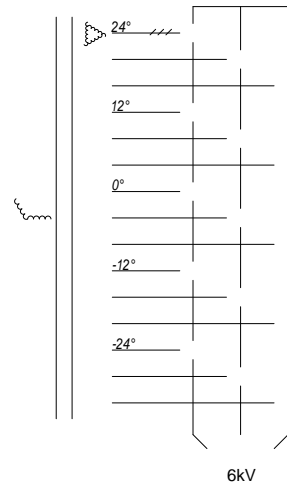
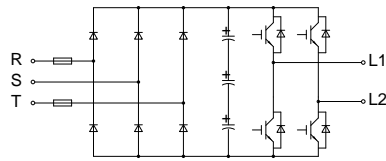
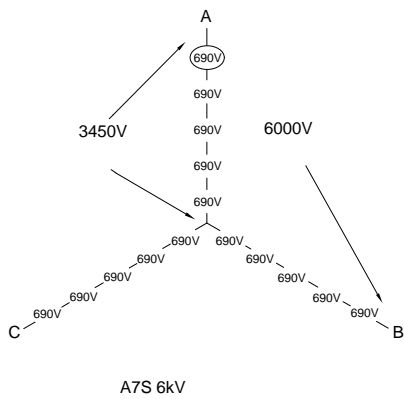

A7S 6kV

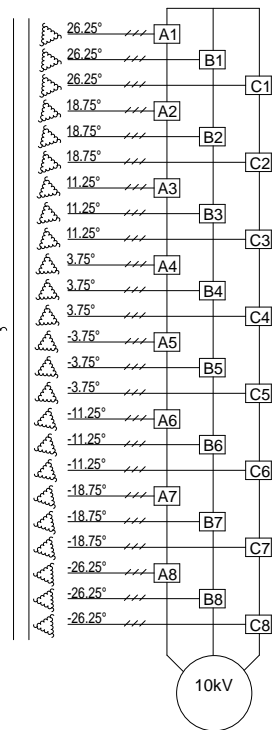
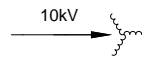
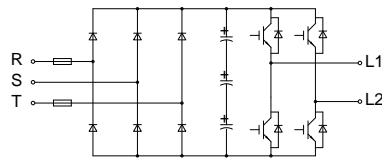
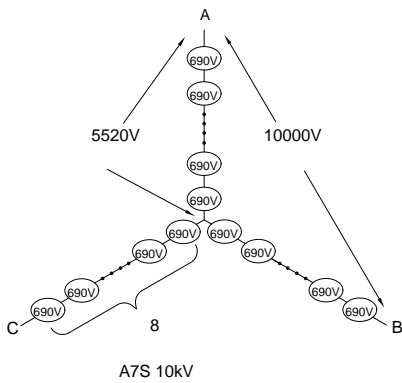

A7S 10kV

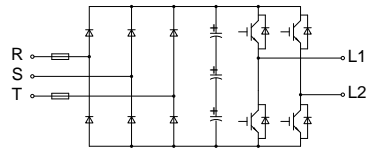

A8S 6kV

6kV

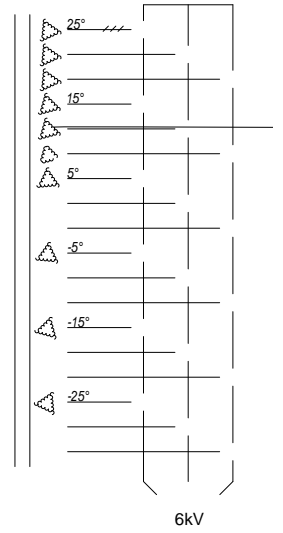

A8S 6kV

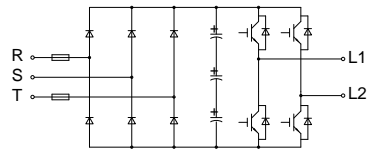
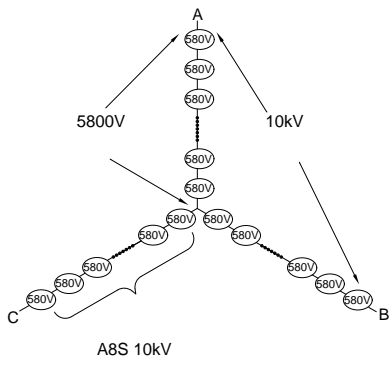

A8S 10kV

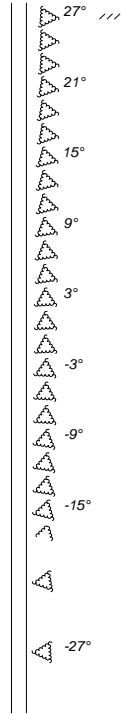



--	--	--	--	--	--	--	--	--	--	--	--	--	--	--	--	--	--	--	--	--

--	--	--	--	--	--	--	--	--	--	--	--	--	--	--	--	--	--	--	--	--

--	--	--	--	--	--	--	--	--	--	--	--	--	--	--	--	--	--	--	--	--

--	--	--	--	--	--	--	--	--	--	--	--	--	--	--	--	--	--	--	--	--





		$\leq 1000\text{V}/\mu$

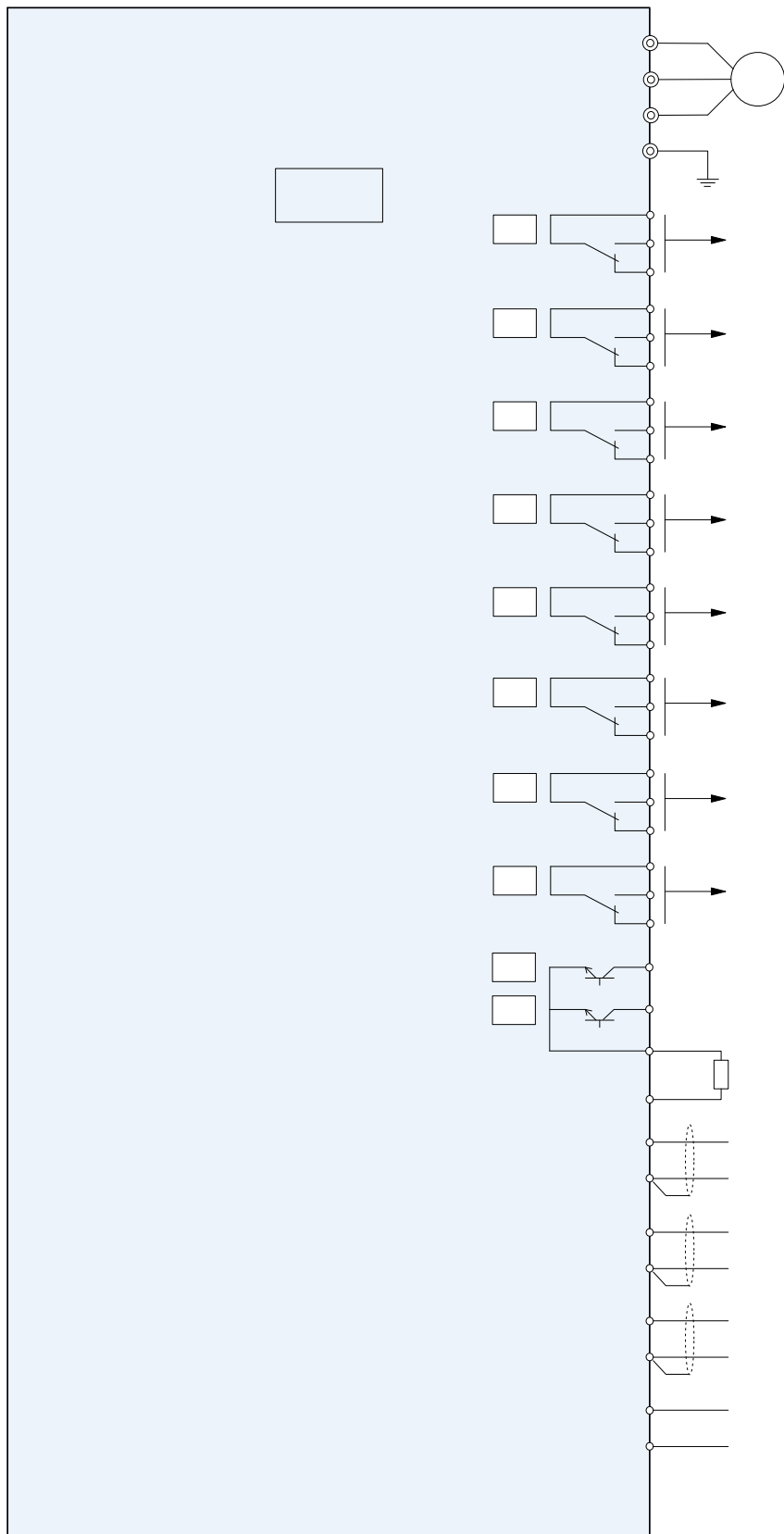

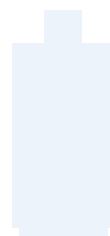
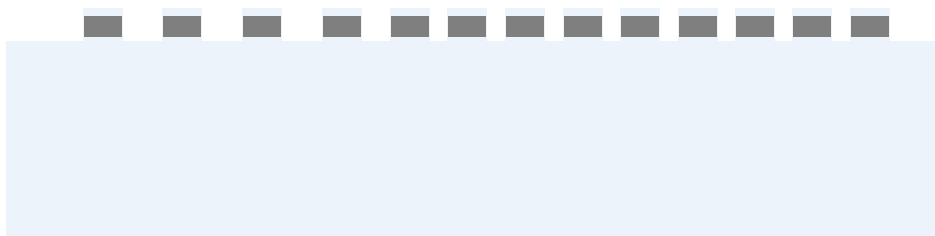
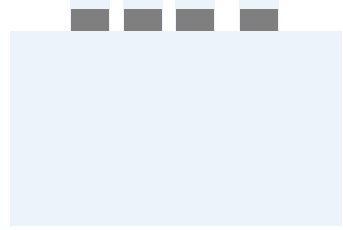
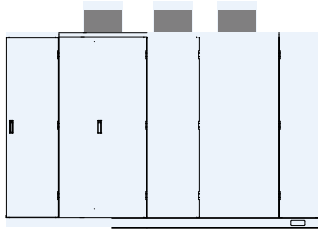
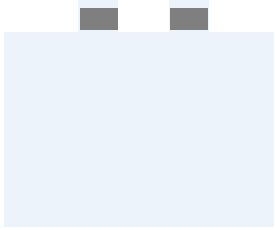

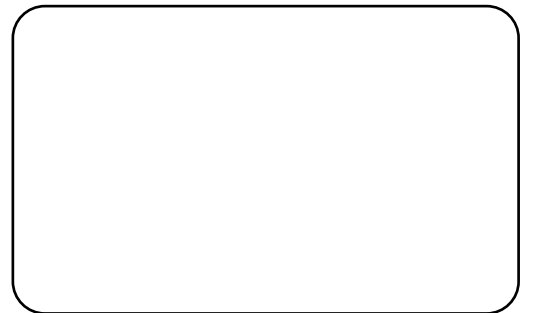

()

