

Leader (amco) - SVC06
Leader (amco) - VM06

PROFIBUS

SC-PB

		- 1 -
1		- 1 -
	1.1	SC-PB	- 1 -
	1.2	- 1 -
	1.3	- 1 -
	1.4	- 2 -
2		- 3 -
	2.1	Profibus :.....	- 3 -
	2.1.1	SVC06-0015 0150/VM06-0022 0185.....	- 3 -
	2.1.2	SVC06-0185 0750/VM06-0220 0900.....	!
	2.1.3	SVC06-0900 2500/VM06-1100 3150.....	!
	2.2	(SW2).....	- 8 -
	2.3	(SW1).....	- 8 -
	2.4	- 9 -
	2.5	- 10 -
3	Profibus	- 11 -
	3.1	Profibus	- 12 -
	3.2	Profibus	- 13 -
	3.2.1	PPO	- 13 -
	3.2.2	PKW	- 14 -
	3.2.3	PZD	- 17 -
	3.2.4	PKW+PZD	- 20 -
4		- 20 -
5	GSD	- 21 -



注意安全

1.1 PROFIBUS DP

1

1.1

SC-PB

SC-PB (PROFIBUS DP)

SC-PB

1.4

Profi bus	DP-V0
	PROFI drive Versi on3
	IEC-61158 61784 GB/T20540-2006
	RS-485
	A
	MG 5G
	9.6K bps 1200m
	19.2K bps 1200m
	45.45K bps 1200m
	93.75K bps 1200m
	187.5K bps 1000m
	500K bps 400m
	1.5M bps 200m
	3M bps 100m
	6M bps 100m
	12M bps 100m
PPO TYPE	PPO TYPE1 TYPE5
	32
	126
LED	/
	-10 +50
	-20 65
	95%RH
	3000m
	5.9m/s2 0.6G JIS C 60068-2-6 IEC60068-2-6

2

2.1 Profibus

:

2.1.1 SVC06-0015 0150/VM06-0022 0185

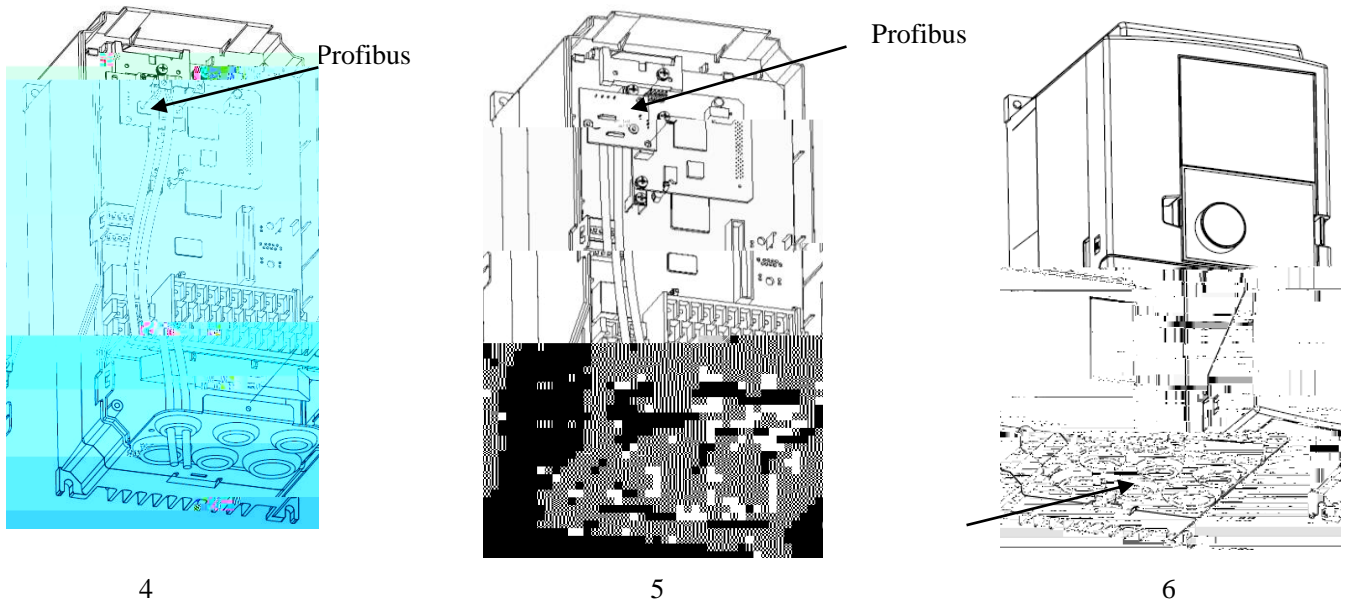
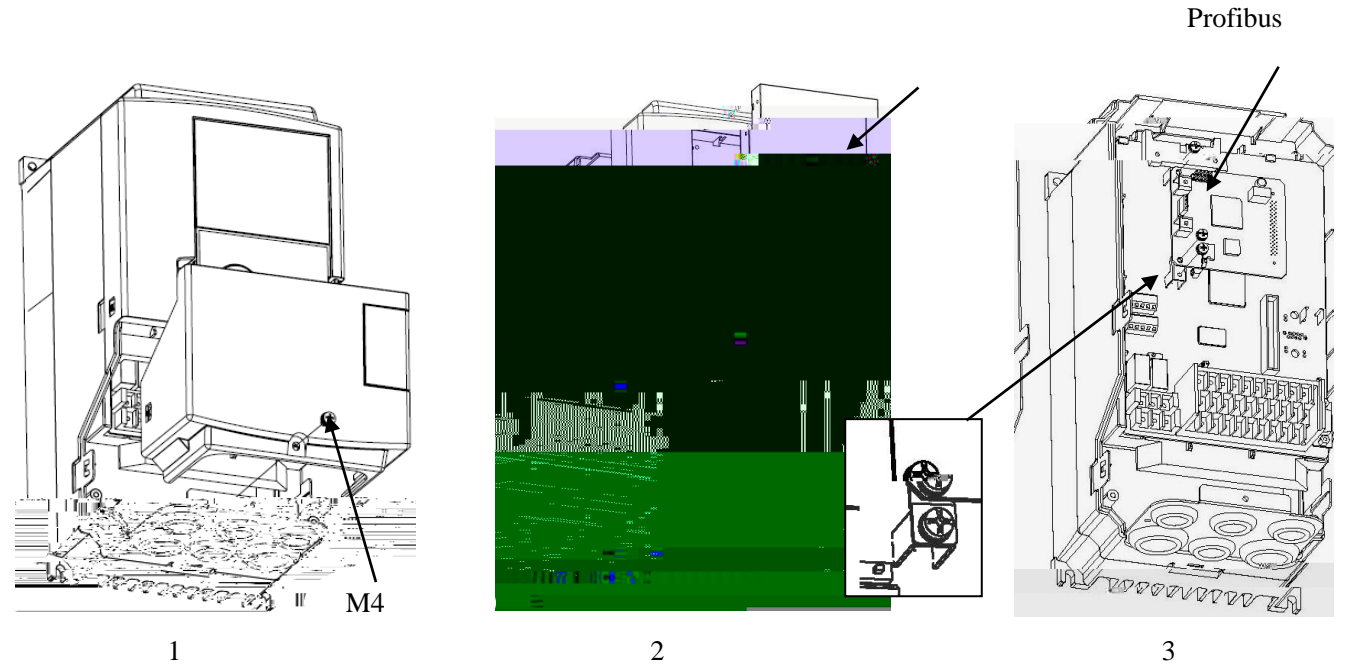

- 1. M4
 - 2. (2)
 - 3. profi bus
 - 4. 2 M3 (4)
- 3 M3
 - Profi bus
 - Profi bus
- 1
 - 3

5. Profi bus 180 Profi bus Profi bus
 2 M3 Profi bus (5)
 6. 5 4 3 2 1 M4 profi bus 6

2.1.2 SVC06-0185 0750/VM06-0220 0900

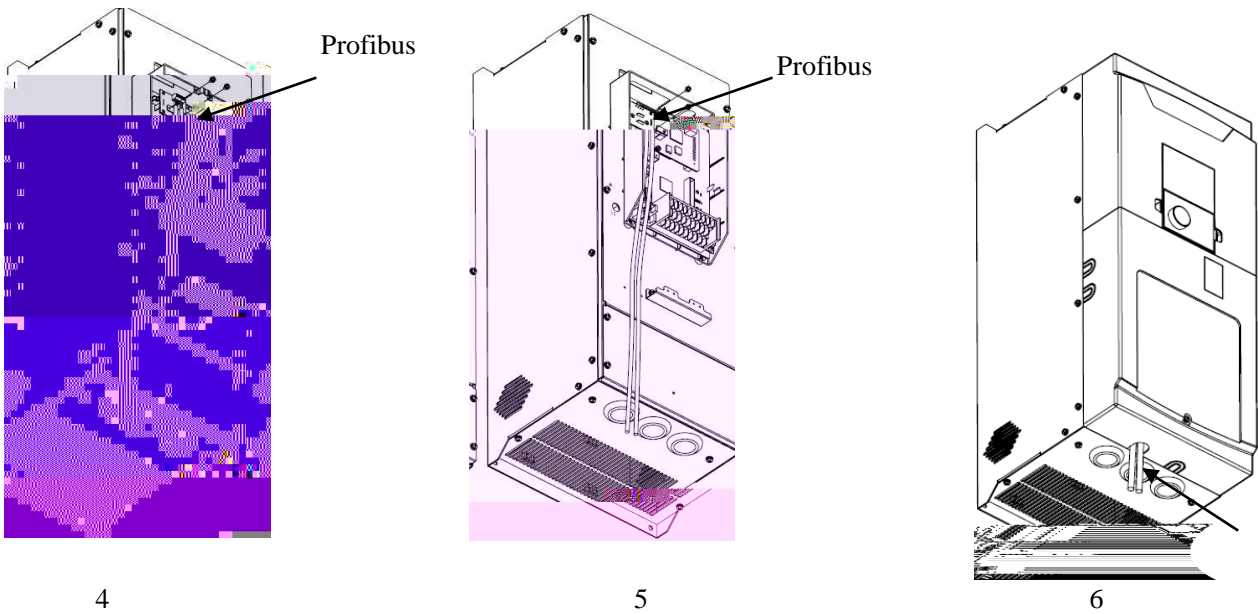
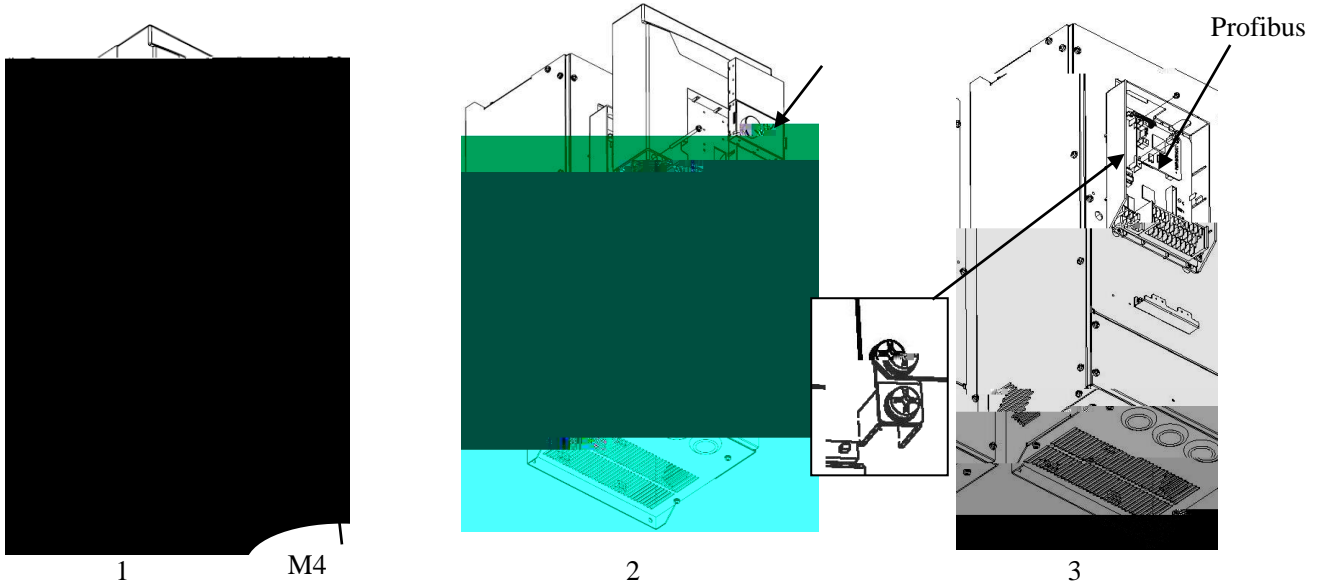

1. M4 1
 2. 2 M4 2
 3. profi bus 3 M3 3
 4. 2 M3 Profi bus Profi bus
 4

5. Profi bus 180 , Profi bus Profi bus
 2 M3 Profi bus (5)
6. 5 4 3 2 1 M4
 profi bus 6

2.1.3 SVC06-0900 250/VM06-1100 3150

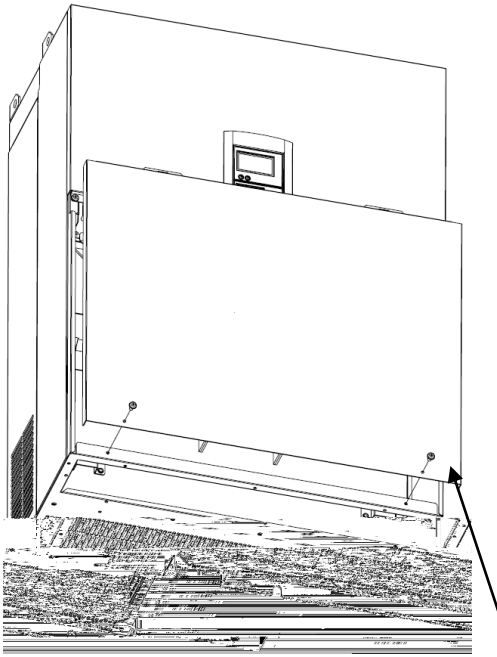

1

M4

M4

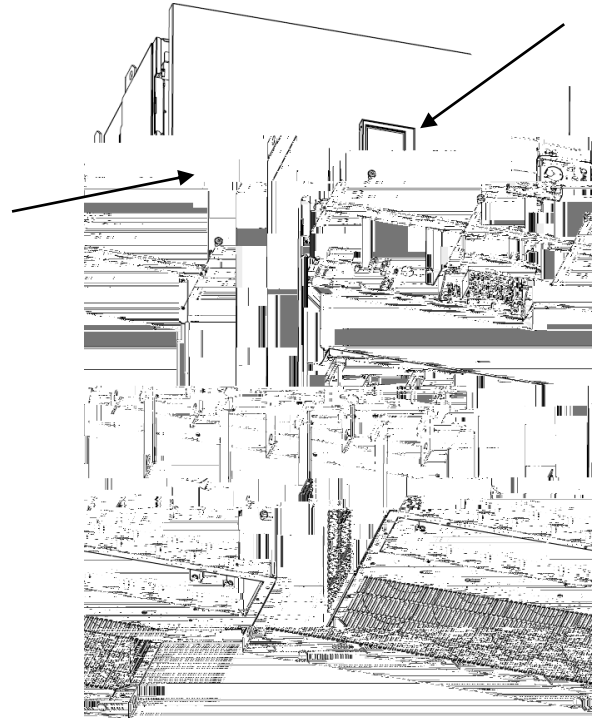

2

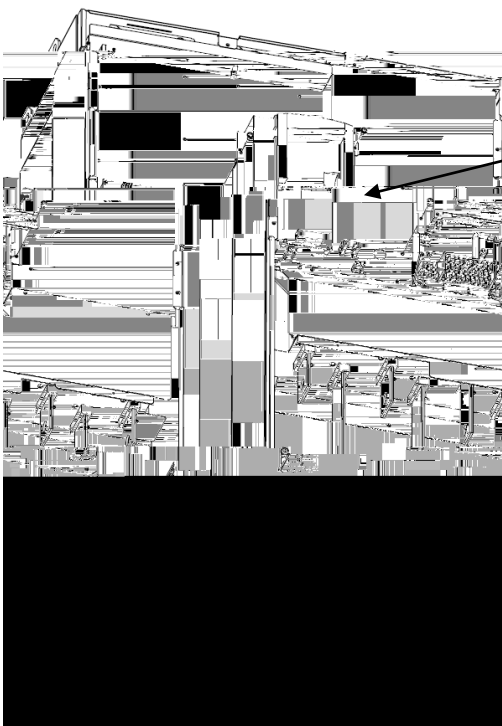

3

M4

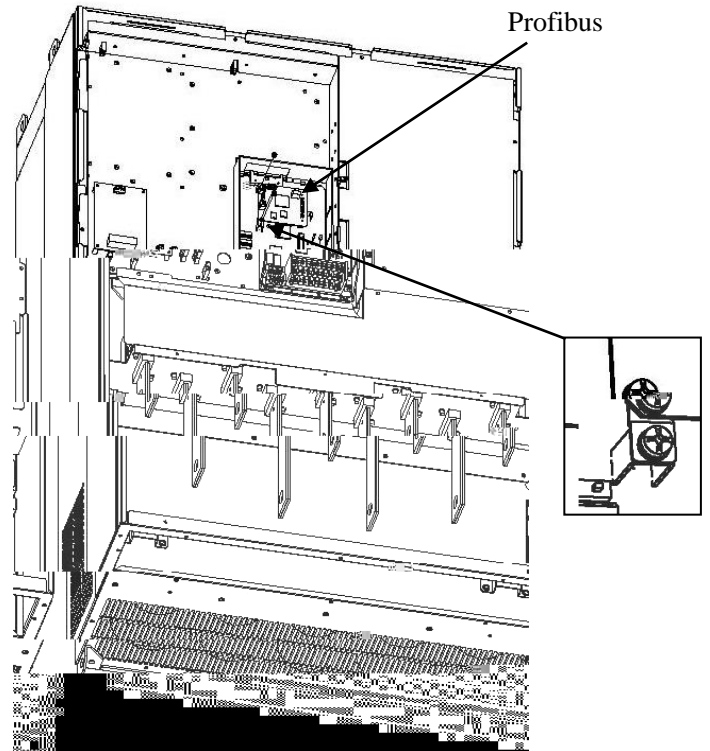

4

Profibus

Profibus

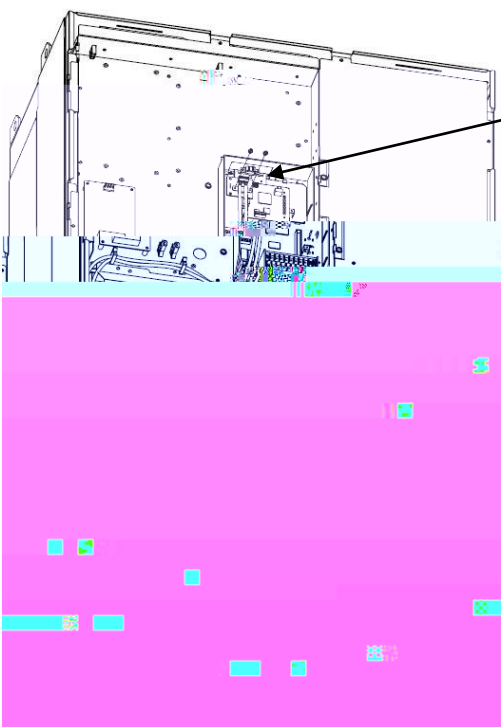

5

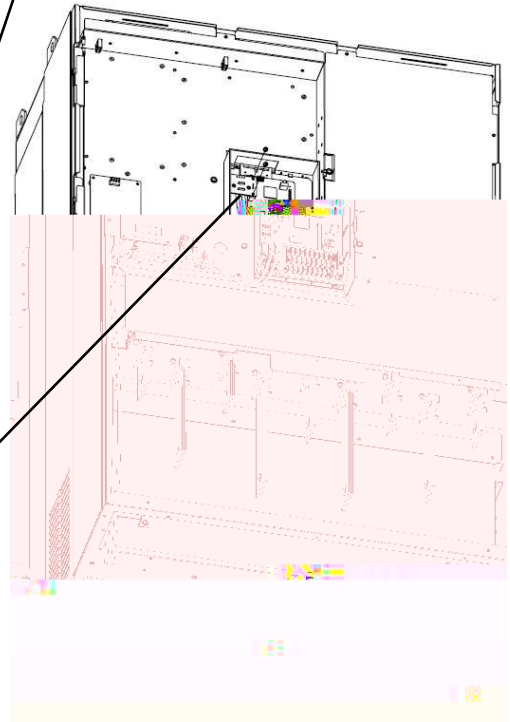
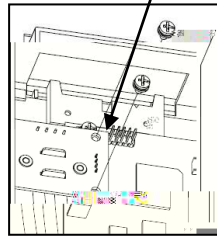
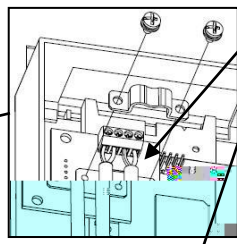

6

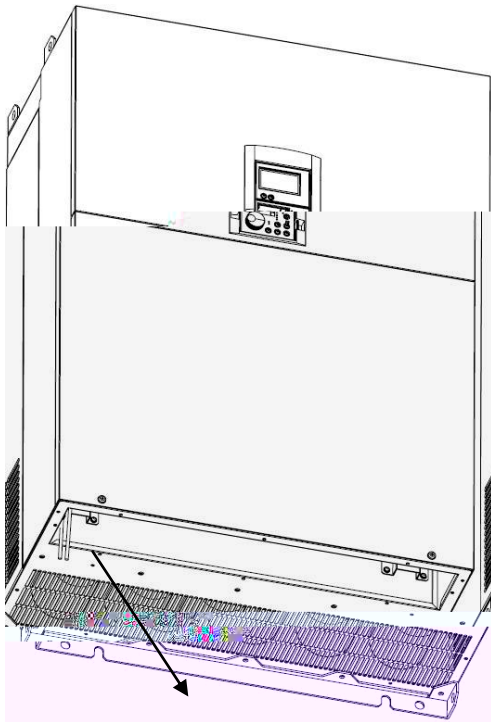

7

1. 2 M4 1
2. , 4 M4
- 2
3. 4 M4 (3)
4. profi bus 3 M3 4
5. Profi bus
- 2 M3 Profi bus
- 5
6. Profi bus 180 , Profi bus Profi bus
- , 2 M3 Profi bus , ,
- (6)
7. 6 5 4 3 2 1 M4 profi bus 7

2.2

(SW2)

SW2

SW2	LB	1	2	3	4	5	6	7	8	HB
		bi t0	bi t1	bi t2	bi t3	bi t4	bi t5	bi t6	NUL	

ON	ON	1
OFF		0

3

03H

00000011

OFF, OFF, OFF, OFF, OFF, ON, ON

SW2	1	2	3	4	5	6	7	8
	ON	ON	OFF	OFF	OFF	OFF	OFF	NUL

2.3

(SW1)

Profibus

SW1

TR_ON	PD_ON	PU_ON

" ON"

:

2.4

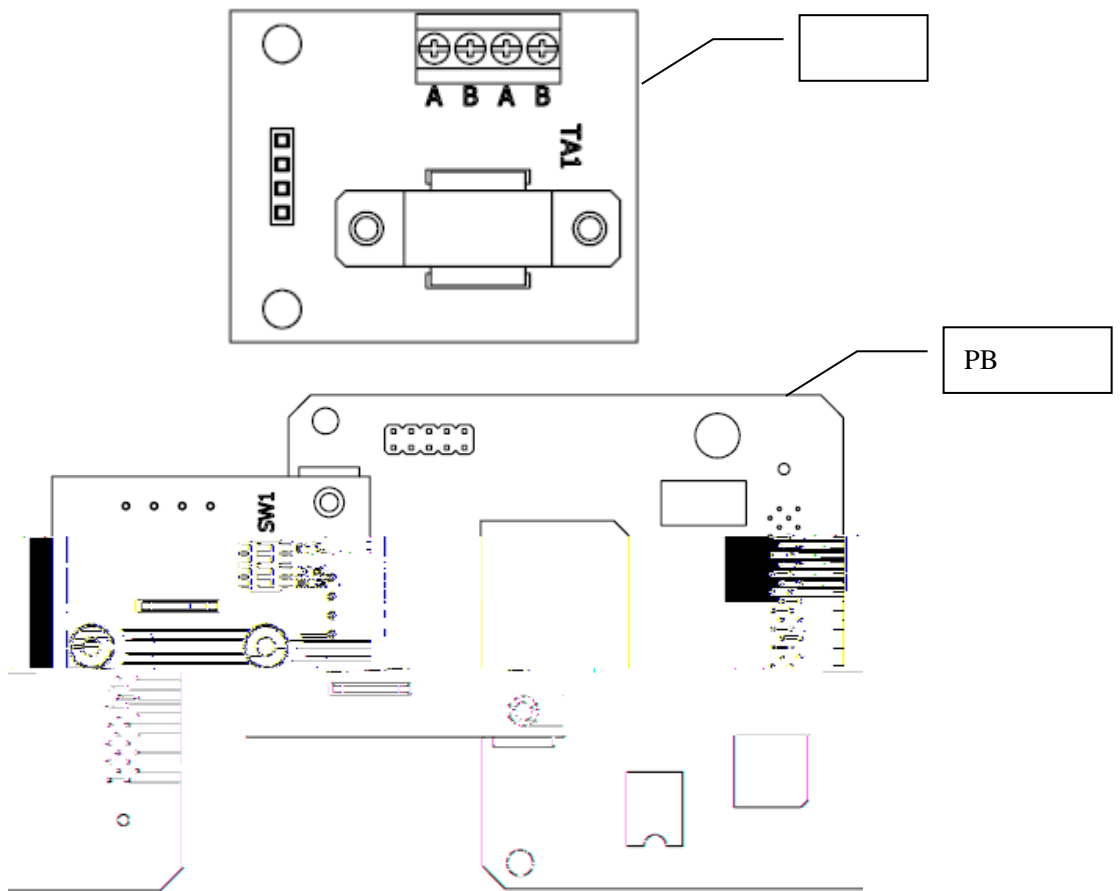

TA1:

B: 485 B- B

A: 485 A+ A

Profibus SW1 4 3 1

MG_ON MG

SG_ON SG

TR_ON

:

PLC

TA1

PROFIBUS
MG/SG

:

2.5



1.

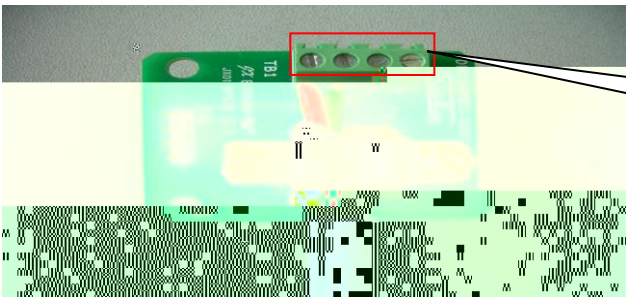

2. 2

4 2

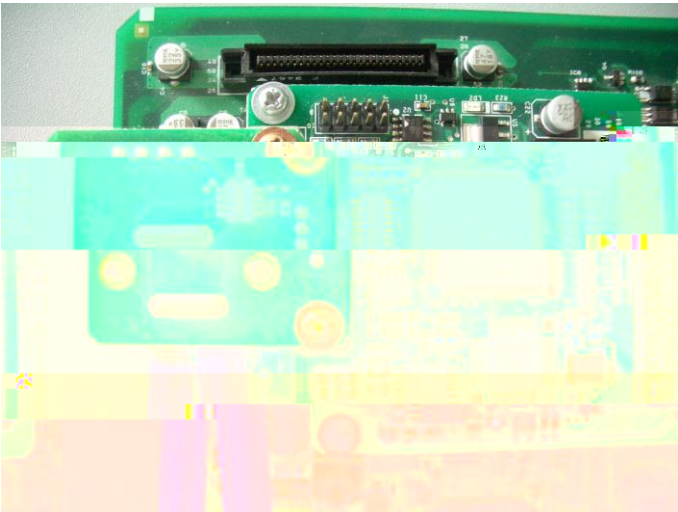

3.

3 Profibus

- 1. F4005 = 3 profibus dp
- 2. F1101 = 3 , ()
- 3. F1002 = 22
F6101 = 11, F1001=3, 4
- 4. F4101 0 600S
- 5. F4102 1:
2:
- 6. F8302 PPO 1 5
6 profibus

3.1 Profibus

F4005		1B	0 1 2 Modbus 3 Profibus DP	1
F8301	Profibus	1B		1
F8302	PP0	1B	1 PP01 2 PP02 3 PP03 4 PP04 5 PP05	1
F8303	PZD3	1B	=0	1
F8304	PZD4	1B	=1 PROFIBUS	
F8305	PZD5	1B	=2 " 0"	
F8306	PZD6	1B	=3	
F8307	PZD7	1B	=4 100	
F8308	PZD8	1B	=5 10	
F8309	PZD9	1B	=6 10	
F8310	PZD10	1B	=7	
			=8 10	
			=9 1	

3.2 Profibus

3.2.1 PPO

Profibus		PP01	PP05	F8302
F8302	=1	PP01		
	=2	PP02		
	=3	PP03		
	=4	PP04		
	=5	PP05		

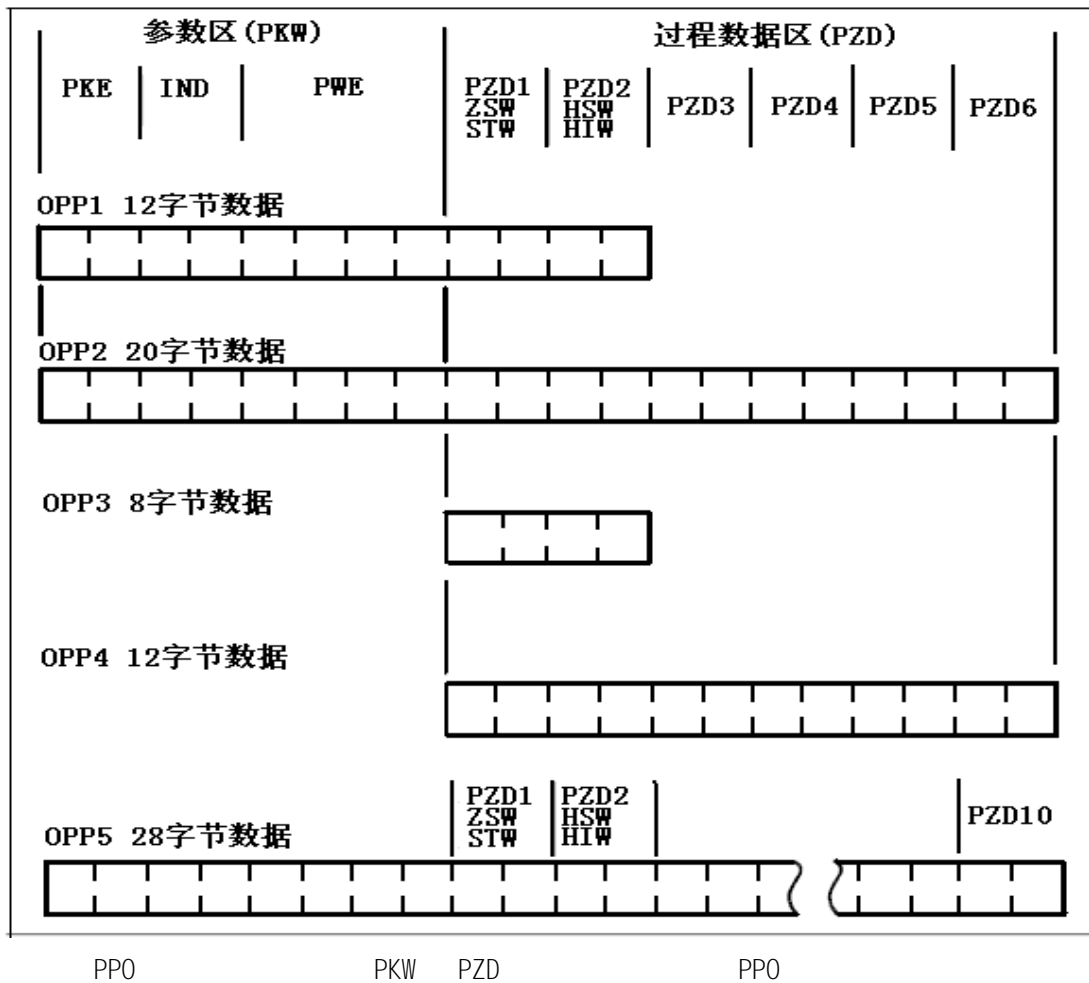

PP0

PP01			
PP02			
PP03			
PP04			
PP05			

3.2.2 PKW

PKW 8bytes PKE 2bytes IND 2bytes PWE 4bytes PKW
 /
 1 PKE BIT

BIT	PP0 ()	PP0
0	PNU PNU	
1		
2		
3		
4		
5		
6		
7		
8		
9		
10		
11	SPM = 0	SPM = 0
12	ID ID	ID ID
13		
14		
15		

PNU 10

PNU	/	
0	-	
10 99	/	IND /
918		
919		
947		
963		PROFIBUS ()
1000		" 0"
1001		100
1002		10
1003		10
1004		
1005		
1006		1
1007		2
1008		
1009		10
1010		VIF1
1011		VIF2
1012		VIF3

PNU =10 99 IND

0	12	MBaud
1	6	MBaud
2	3	MBaud
3	1.5	MBaud
4	500	kBaud
5	187.5	kBaud
6	93.75	kBaud
7	45.45	kBaud
8	19.2	kBaud
9	9.6	kBaud

ID

ID

ID			ID	
0			0	
1			1	
2			4	IND
6	IND		7	PWE
7	IND			

ID

=7

PWE

PWE

2

PWE

0		
1		
2		-
3		
4	ID	ID
11		
18		-
101		
102		
103		
104		
105		
106	LV	
107		

PPO

16

PKE		IND		PWE			
BYTE1	BYTE0	BYTE1	BYTE0	BYTE3	BYTE2	BYTE1	BYTE0
73	96	00	00	00	00	00	04

04 PPO

4 < F1006 > PKW

PPO

16

PKE		IND		PWE			
BYTE1	BYTE0	BYTE1	BYTE0	BYTE3	BYTE2	BYTE1	BYTE0
70	0A	06	00	00	00	13	88

PPO

16

PKE		IND		PWE			
BYTE1	BYTE0	BYTE1	BYTE0	BYTE3	BYTE2	BYTE1	BYTE0
40	0A	06	00	00	00	13	88

3.2.3 PZD

1 STW ZSW PZD1=2bytes

STW			
Bi t0	1	ON	
	0		
Bi t1	1	1	
Bi t2	1	1	
Bi t3	1	Bi t11	
	0		
Bi t4, 5, 6	1	1	
Bi t7	0 1		
	0		
Bi t8, 9	1	1	
Bi t10	1		
	0		
Bi t11	0		
	1		
Bi t12, 13, 14, 15		0	

ZSW			
Bi t0	1		
	0		
Bi t1	1		
	0		
Bi t2	1		Bi t3
	0		
Bi t3	1		
	0		
Bi t9	1		
	0		
Bi t10	1		
	0		
Bi t14	0		Bi t11
	1		
Bi t15	1		
	0		
		0	

2 HSW

HIW

PZD2=2bytes

100

1 <PP01

50Hz> PZD1 PZD2

+			
16			
STW	PZD1	HSW	PZD2
BYTE1	BYTE0	BYTE1	BYTE0
04	7F	13	

PZD3	PZD10			
PZD3	F8303	=0		
PZD4	F8304	=1	PROFI BUS	
PZD5	F8305	=2		" 0"
PZD6	F8306	=3		
PZD7	F8307	=4		100
PZD8	F8308	=5		10
PZD9	F8309	=6		10
PZD10	F8310	=7		
		=8		10
		=9	1	
		=10	2	
		=11		
		=12		10
		=13	VIF1	
		=14	VIF2	
		=15	VIF3	

+ +PZD3 PZD10 16

STW	PZD1	HSW	PZD2	PZD3		PZD4		PZD5 PZD10
BYTE 1	BYTE0	BYTE1	BYTE0	BYTE1	BYTE0	BYTE1	BYTE 0	00
04	7F	13	88	00	00	00	00	

+ 16

STW	PZD1	HSW	PZD2	PZD3		PZD4		PZD5 PZD10
BYTE 1	BYTE0	BYTE1	BYTE0	BYTE1	BYTE0	BYTE1	BYTE 0	00
06	07	00	00	00	00	00	1A	

3.2.4 PKW+PZD

		PKE	IND	PWE. H	PWE. L	PZD1	PZD2	PZD3--PZD10
	40.96	0	0	0	0	47E	0	0
	40.96	0	0	0	0	47F	1000	0
	40.96	0	0	0	0	C7F	1000	0
	40.96	0	0	0	0	476	1000	0
	40.96	0	0	0	0	4FE	1000	0
	40.96	1396	0	0	0	476	1000	0

4

LED

LD1		LCD	PPO SC-PB
LD2			OTP2
PLC LED	DP PLC	LED	1. PLC SC-PB DP (MG/5G) 2.

5 GSD

```
=====
; GSD-File for SC-PB Sanken LD
; MLFB :
; Auto_Baud_supp, 12MBaud
;
; File : SankenLD.GSD
=====

#Profibus_DP
; Unit-Definition-List:
GSD_Revision = 1
Vendor_Name="Sanken LD"
Model_Name = "Sanken L.D. SVC06 Profibus"
Revision = "Rev 1.0"
Ident_Number = 0x8
Protocol_Ident = 0
Station_Type = 0
FMS_supp = 1
Hardware_Release = "1.00"
Software_Release = "1.00"
9.6_supp = 1
19.2_supp = 1
93.75_supp = 1
187.5_supp = 1
500_supp = 1
1.5M_supp = 1
3M_supp = 1
6M_supp = 1
12M_supp = 1
MaxTsdr_9.6 = 60
MaxTsdr_19.2 = 60
MaxTsdr_93.75 = 60
MaxTsdr_187.5 = 60
MaxTsdr_500 = 100
MaxTsdr_1.5M = 150
MaxTsdr_3M = 250
MaxTsdr_6M = 450
MaxTsdr_12M = 800
Redundancy = 1
Repeater_Ctrl_Sig = 2
;
; Slave-Specification:
24V_Pins = 2
```

```

;
Implementation_Type = "SPC3"
Bitmap_Device      = "DP_NORM"
Bitmap_Diag       = "bmpdia"
Bitmap_SF         = "bmpsf"
Freeze_Mode_supp  = 0
Sync_Mode_supp    = 0
Auto_Baud_supp    = 1
Set_Slave_Add_supp = 0
Min_Slave_Intervall = 1
;
Modular_Station   = 1
Max_Module        = 1
Max_Input_Len     = 122
Max_Output_Len    = 122
Max_Data_Len      = 244
;
; Module-Definitions:
;
Modul_Offset      = 255
Max_User_Prm_Data_Len = 5
Fail_Safe         = 0
Slave_Family      = 0
Max_Diag_Data_Len = 16
OrderNumber="SVC06 PROFIBUS"

Module = "PPO Type 1" 0xF3, 0xF1;
EndModule;
Module = "PPO Type 2" 0xF3, 0xF5;
EndModule;
Module = "PPO Type 3" 0xF1;
EndModule;
Module = "PPO Type 4" 0xF5;
5;

```

: www.sankenld.com

2021 09

VER-2.24
TEXC-SC-PB-004B